

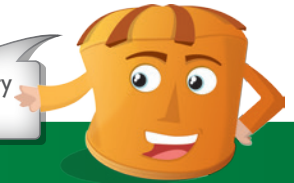

**terracorp**  
INDUSTRIES

**1300 784 489**  
www.terracorptanks.com.au

Made in the Territory  
for Territorians



## IN-GROUND SEPTIC TANKS

- ✓ Northern Territory Government Department of Health approved 3000L septic tank
- ✓ Product Approval Number 01/16
- ✓ Complies to AS/NZ 1546.1.2008 standard
- ✓ Quality tested for thickness and strength
- ✓ Environmentally safe - no risk of contamination to the environment
- ✓ Easy to service
- ✓ Stepped ribbed one piece design (no separate lid) for added strength and durability
- ✓ Anchor points to stop uplift
- ✓ Built tough to retain structural integrity
- ✓ Ready to install



If you want a certified, approved and locally manufactured septic tank, give us a call today!

### STANDARD TECHNICAL SPECIFICATION

#### Product specifications:

Weight: 150kg / Height: 1830mm / Diameter at top: 2000mm / Diameter at base: 1550mm

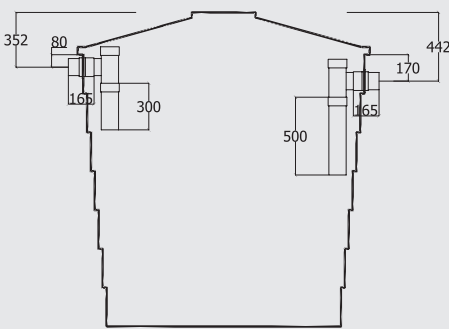

Section - Septic

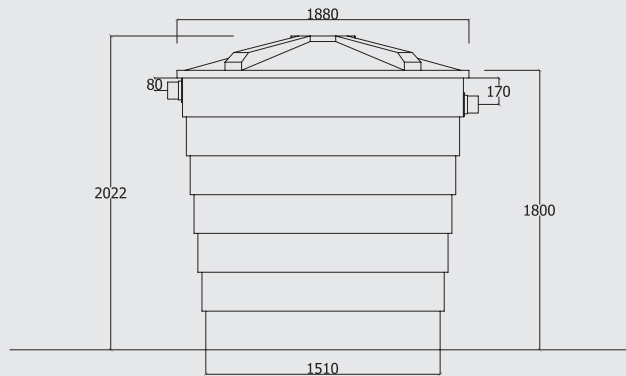

Elevation - Septic

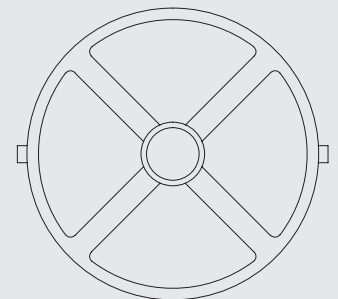

Plan - Septic

**MADE IN THE TERRITORY BEST PRODUCT BEST SERVICE**

For more information on our full product range, visit [www.terracorptanks.com.au](http://www.terracorptanks.com.au)

Visit us at: 9 Beresford Road, Yarrowonga, Palmerston NT 0830

Phone: 1300 784 489 or 8932 8222 Email: [info@terracorp.com.au](mailto:info@terracorp.com.au)

ABN 65 992 045 074

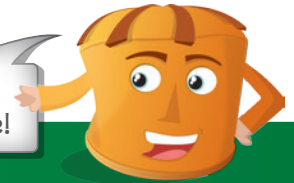

# TANKS

## WATER TANKS

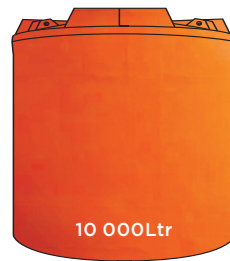
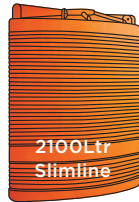

PRODUCT CODE	DESCRIPTION	WEIGHT (KG)	DIAMETER (MM)	HEIGHT (MM)	CAPACITY (LTRS)
WT550	550 Ltr Water Tank	25	780	1195	550
WT1	1000 Ltr Water Tank	31	1140	1270	1000
SL2100	2100 Ltr Slimline	125	820 x 1920	1900	2100
WT3	3000 Ltr Water Tank	75	1720	1430	3000
WT5	5000 Ltr Water Tank	112	1720	2180	5000
WT10	10 000 Ltr Water Tank	175	2400	2220	10 000
WT25	25 000 Ltr Water Tank	400	3450	3050*	25 000
WT30	30 000 Ltr Water Tank	500	3450	3390**	30 000

\*Manhole height 2650 from ground \*\*Manhole height 3030 from ground

## STANDARD FIT OUT FOR TANKS

- Manhole in roof with capped lid or Channell fitting (for rainwater collection)
- 90mm PVC overflow with mosquito screen
- Top and bottom factory installed inlet and outlet with a male BSP thread, with a sizing of 25mm up to 50mm



## Terracorp Industries Quality Management System Complies with AS/NZS ISO 9001:2008

Our registration covers the QMS for design, development and manufacture of plastic water tanks and plastic products.

For more information on our full product range, visit [www.terracorptanks.com.au](http://www.terracorptanks.com.au)

Visit us at: 9 Beresford Road, Yarrowonga, Palmerston NT 0830

Phone: 1300 784 489 or 8932 8222 Email: [info@terracorp.com.au](mailto:info@terracorp.com.au)